



**SERIOUS SERVICE®**  
Professional Machinery Health Care  
(Fan Doctor®)



**VIBES Corp®**



Est. 1967

Vibration Industrial Balancing & Equipment Services, Corporation

720 - 999 W. Broadway, Vancouver, BC V5Z 1K5

www.vibescorp.ca email: info@vibescorp.ca

Phone: 604 - 619 - 9381 (24/7)

**VIBRATION DIRECTION**

Vibrations in machinery can be measured in radial, axial, and tangential directions. The intent is to detect the direction of the largest signal. Generally, the strongest signals are in the Radial direction. Machine mountings can affect vibration readings. A machine mounted on isolators such as spring isolators may have strong vertical vibration signals. Bent shafts and loose bearings can sometimes cause large axial vibration signals. Therefore it is best to take vibration readings in all three directions when possible.

**MEASUREMENT POINTS**

The following diagrams provide suggested vibration monitoring points. Generally, it is best to take readings on, or as close as possible to the bearings of the rotating machinery being tested. Vibration signals are strongest around bearings and tend to get weaker farther away from the bearings. Caution must be taken when working around rotating machinery, belts, pulleys and shafts.

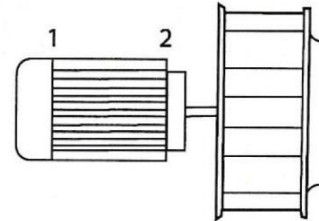

**MOTOR SHAFT MOUNTED FAN**

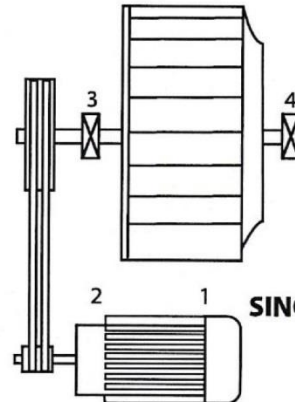

**SINGLE INLET CENTRIFUGAL FAN**

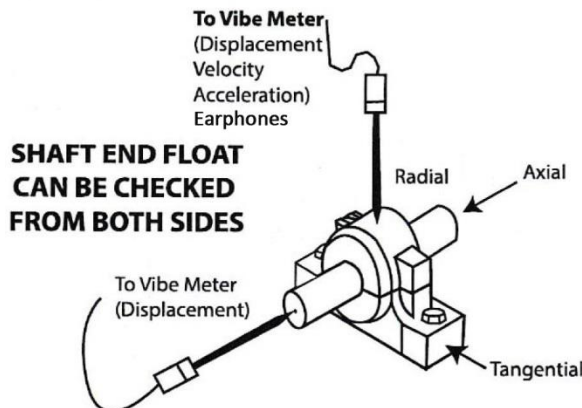

**SHAFT END FLOAT CAN BE CHECKED FROM BOTH SIDES**

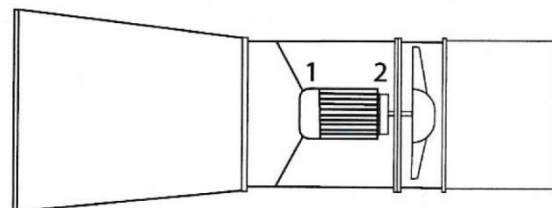

**AXIAL FAN**



Vendor Compliant for Property Owners, Management Firms of Commercial Buildings, Hospitals, Industrial Sites, & Infra-Structure Facilities



**SERIOUS SERVICE®**  
Professional Machinery Health Care  
(Fan Doctor®)



**VIBES Corp®**



Est. 1967

Vibration Industrial Balancing & Equipment Services, Corporation

720 - 999 W. Broadway, Vancouver, BC V5Z 1K5

www.vibescorp.ca email: info@vibescorp.ca

Phone: 604 - 619 - 9381 (24/7)

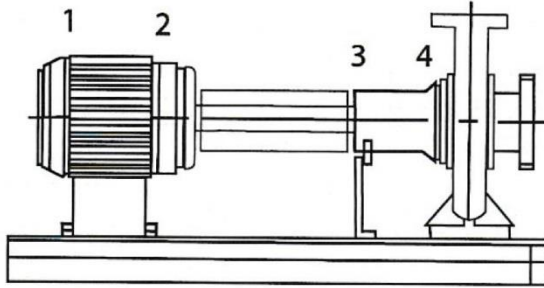

**DIRECT DRIVEN PUMP**

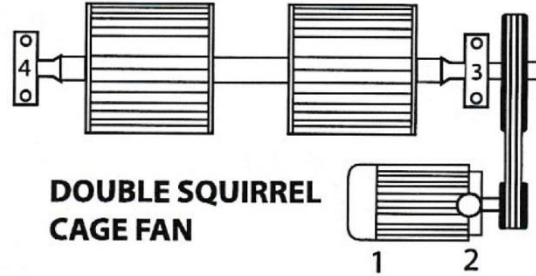

**DOUBLE SQUIRREL  
CAGE FAN**

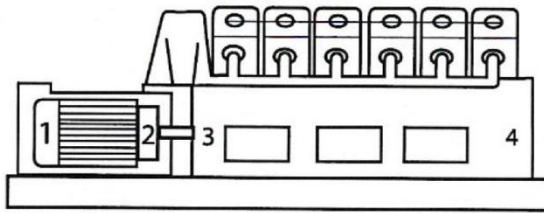

**DIESEL ENGINE / GENERATOR**

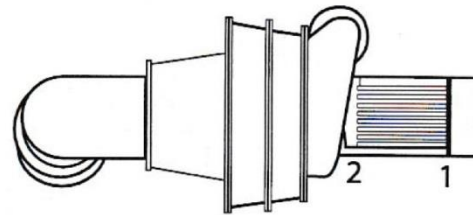

**CENTRIFUGAL CHILLER**

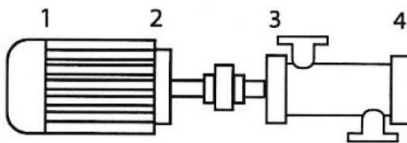

**DIRECT DRIVEN COMPRESSOR**

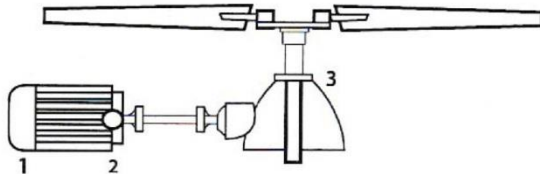

**MOTOR - DRIVE - SHAFT - GEARBOX  
INDUCED DRAFT - COOLING TOWER**

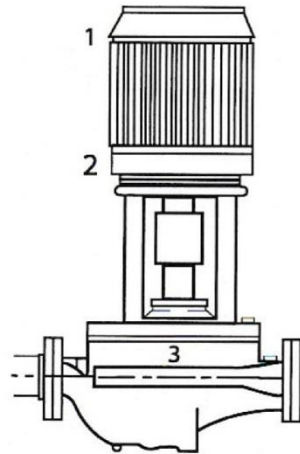

**DIRECT DRIVEN  
INLINE PUMP**



Vendor Compliant for Property Owners, Management Firms of Commercial Buildings, Hospitals, Industrial Sites, & Infra-Structure Facilities